

APM Buildings

Pole Building Options

Options

No Overhang
1ft OH painted fascia & white vinyl soffit (eve sides)
1ft OH painted fascia & painted soffit (eve sides)
1ft OH painted fascia & white vinyl soffit (all sides)
1ft OH painted fascia & painted soffit (all sides)
Wainscoting
2' Translucent Sidelights Eve Side
Liner Panel on Inside Ceiling of building
Double Bubble Roof Insulation -ESP
Perma-Columns (Included w/ Post)
Snow Guards - Stainless Painted - row 18" oc

Entry Doors

36"- 6 Panel Entry Door w/ knob
36"- 9 Lite Entry Door w/ knob
72" - Double Door (both doors swing- full opening)

Windows

36"x36" Slider Window Vinyl
36" x 44" Single Hung Window Vinyl
36" x 48" Double Hung Window Vinyl

Garage Doors

9x7 Overhead Garage Door w/ header
9x8 Overhead Garage Door w/ header
10x8 Overhead Garage Door w/ header
10x10 Overhead Garage Door w/ header
10x12 Overhead Garage Door w /header
12x12 Overhead Garage Door w/ header
16x7 Overhead Garage Door w/ header
16x8 Overhead Garage Door w/ header

Sliding Doors

Gable or Eve Side w/ header
Gable or Eve Side w/ header
Gable Side w/ header

Shutters

15x36 Cathedral Top Louver Shutters - Vinyl
15x48 Cathedral Top Louver Shutters - Vinyl
15x35 Raised Panel Shutters - Vinyl
15x47 Raised Panel Shutters - Vinyl

Cupola

24"x24" Cupola model 240
36"x36" Cupola model 360
48"x48" Cupola model 480

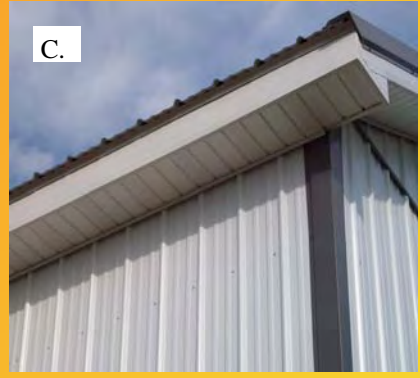
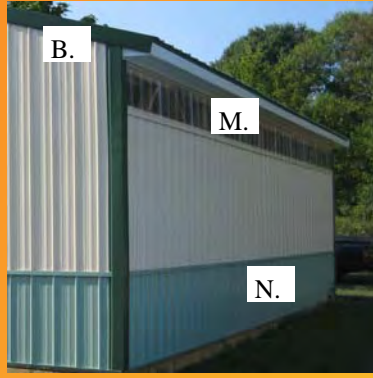

- A. No Overhang
- B. 1' Overhang Eve Only
- C. 1' Overhang all 4 sides
- D. Liner Panel- Ceiling
- E. Entry Door 9 Lite
- F. Vinyl Shutters
- G. Perma-Columns
- H. Double Bubble Roof Insul. ESP
- I. Snow Guards
- J. Garage Door
- K. Sliding Door—Single
- L. Sliding Door—Double
- M. 2' Translucent Sidelights
- N. Wainscoting



Lifetime Warranty

Tuff-Post

Engineered Wood Pole Building Posts

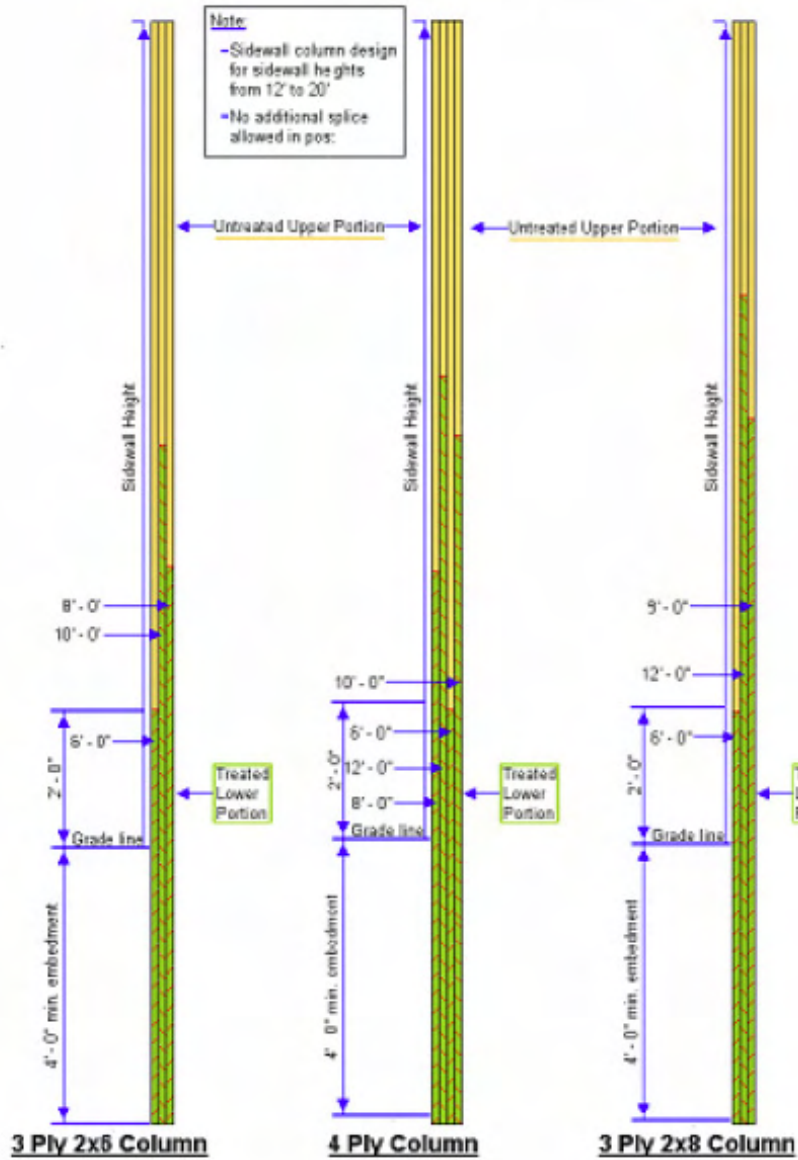



Ridge Vent for Metal Roofing

Fastvent Plus™ provides ventilation and uniform air flow for the proper maintenance of metal roofs. Uniquely engineered breathable closure strips eliminate any leak path into the ridge area by completely sealing against the panel profile. This form-fit reduces wind-driven rain problems to a minimum. Closed cell polyethylene completely surrounds the open-cell venting foam.

- Tight seal
- Low profile
- Superior venting
- Easy install - Contractor friendly
- Fire retardant/UV stable
- Permanent glue strips
- 1 3/4" wide x 3' long/25 pieces per box



	Width	Length	Ft per bx	Pcs/Bx	Lb/Bx
FASPLU	1.75"	3'	75'	25	5

Fastvent Plus™ Ridge Vent Specs

- Net free area: 15 sq. in. per lineal ft. per ridge
- Air Permeability: 760 cubic feet per minute
- Snow Infiltration: 0



TempShield™ Double Bubble White/Foil

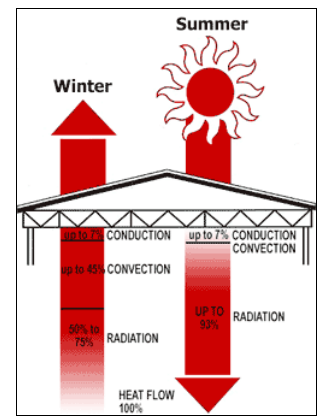

TempShield™ Brand Double Bubble White/Foil is **two** layers of 5/32" barrier bubble film laminated between **one** layer of metalized film and one layer of white polyethylene.

TempShield™ Double Bubble White/Foil is designed to be used for concrete slab pad or metal buildings where aesthetics is of primary importance.

TempShield™ Double Bubble White/Foil in a concrete slab application is two-fold; first, it acts as a vapor retarder and second, it provides a thermal break. The thermal resistance of TempShield™ product under concrete is based on testing done on a calibrated hot-plate using ASTM 518 test procedures.

Key Benefits

- Clean, Lightweight, Easy To Install
- White Appearance

Saves Energy and Money



How Radiant Heat Transfers Through Roofs

TempShield™ is used as insulation against radiant heat transfer and can be used to its greatest advantage in instances where radiation is the predominant means of heat transfer. It is the bright aluminumized film surface of all TempShield™ products that gives it its insulating properties. This happens in two ways:

TempShield™ is an excellent reflector of all long wave radiant heat that strikes it - reflecting up to 95% of all radiant heat.

TempShield™ will reradiate only 5% of heat in which it comes in close physical contact, compared with the approximate 90% reradiation of ordinary building materials, at the same temperature.

The thermal values for roof applications in post frame construction were derived by testing an assembly consisting of a corrugated metal exterior, 2" x 4" purlins, TempShield™ Insulation, a 2" x 6" to represent the top cord of a truss, and 1/2" wafer board. The thermal values are for both exposed insulation and applications where the insulation is covered for fire codes.

Thermal Values	Heat Flow Up	Heat Flow Down	U Value Up	U Value Down	K Value Up	K Value Down
TempShield™	6.93	15.11	.144	.066	.144	.066
TempShield™	6.22	14.40	.161	.069	.161	.069
TempShield™	4.91*	12.81*	.204*	.078*	.204*	.078*

All Thermal Values are corrected for frame loss.

* Includes thermal resistance of 1.32 UP and 4.55 DOWN for interior air film.

PRODUCT: Two layers of 5/32" barrier bubble film laminated between one layer of metalized film and one layer of polyethylene.

THICKNESS: 5/16" nominal

FIRE RATING: Class A/Class 1

ROOF CUPOLAS

- Now available in 24", 36" and 48" sizes with a straight roof. The entire 24" and 36" cupola is constructed of 29 gauge prepainted steel. The 48" cupola has a 26 gauge prepainted steel roof.
- Prepainted steel roof construction with the 24", 36" and 48" available in numerous colors. Sides are standard in white. Contact sales representative for other colors.
- Assembles on job site in minutes with slide on metal connectors for straight roof and wall sections.
- Bird screen included for mounting in curbs.
- Roof interlocks with sides for tight connection.
- All metal joints feature "Tog-a-Loc" construction, for non-rusting permanent construction.
- Optional curb cap if no air flow for ventilation is required.
- Packaged KD for economical shipping, with fast, easy assembly on building site.



PLYCO
CORPORATION

Due to Plyco Corporation's ongoing commitment to product improvement, we reserve the right to change, without notice, product specifications, availability, prices and conditions of sale. Products are shown with options, please contact your representative.

P.O. Box Q, Elkhart Lake, WI 53020
USA: 800-558-5895 • Fax 800-257-5926
INTERNATIONAL: (920) 876-3611 • Fax (920) 876-3527

5000PlycoRoofCupolas 2-01

ROOF CUPOLAS LITED

- Now available in 24", 36" and 48" sizes with a straight roof. The entire 24" and 36" cupola is constructed of 29 gauge prepainted steel. The 48" cupola has a 26 gauge prepainted steel roof.
- Prepainted steel roof construction with the 24", 36" and 48" available in numerous colors. Sides are standard in white. Contact sales representative for other colors.
- Full perimeter reinforced hemmed angles for rigid window frame opening.
- Galvanized steel internal gussets for diagonal strength.
- Plyco manufactured acrylic glazed white aluminum windows installed in each side with permanent silk-screened gridwork.
- All metal joints feature "Tog-a-Loc" construction, for non-rusting permanent construction.
- Packaged KD for economical shipping, with fast, easy assembly on building site.

PLYCO
CORPORATION

P.O. Box Q, Elkhart Lake, WI 53020
USA: 800-558-5895 • Fax 800-257-5926
INTERNATIONAL: (920) 876-3611 • Fax (920) 876-3527



Due to Plyco Corporation's ongoing commitment to product improvement, we reserve the right to change, without notice, product specifications, availability, prices and conditions of sale. Products are shown with options, please contact your representative.

5000PlycoRoofCupolasLite 2-01

STANDARD CUPOLA SIZES

	MODEL 240	MODEL 360	MODEL 480
BASE SIZE:	24"x24"	36"x36"	48"x48"
SIDE HEIGHT:	16"	21"	28"
ROOF HEIGHT:	15"	21"	28"
OVERALL HEIGHT:	31"	42"	56"
FREE AREA (SQ. IN.):	250	560	990
ROOF OVERHANG:	2"	3"	3"

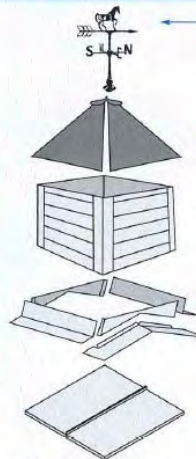

WEATHER VANES:

Attach to cupola roof cap.
29" Height for Models #240 and #360
42" Height for Model #480 (Horse Only)

ROOF: (Standard Colors Below)

MW-240-24" model
MW-360-36" model
MW-480-48" model

SIDES: (Standard White)

MW-245-24" model
MW-365-36" model
MW-485-48" model

6-PIECE BASE FLASHING: (Standard White)

Standard 3/12 or 4/12 pitch, please specify. Any other pitch, special order.

MW-241-24" model
MW-361-36" model
MW-481-48" model

OPTIONAL CURB CAP:

MW-248-24" model
MW-368-36" model
MW-488-48" model

STANDARD ROOF COLORS:

WHITE	GREEN	RED
CHARCOAL	BROWN	BLACK

AVAILABLE STYLES:



PLYCO
CORPORATION

Elkhart Lake, WI 53020
Phone: (800) 558-5895
Fax: (800) 257-5926

Distributed by:

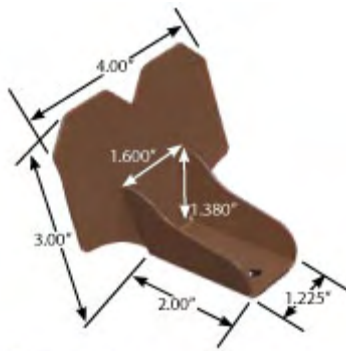

4500



EPDM Rubber Sealer

Snow Defender™ 4500

The patented Snow Defender™ 4500 is the snow guard you need for long lasting protection against melting snow. Designed for use with exposed fastener panels on 2x4 purlins in the flat position.

- Made w/ 16 Gauge Type 304 Stainless Steel
- EPDM Rubber Sealer
- Powder Coated
- **Multiple Colors In Stock**
- 50 Pieces per 15-Pound Box
- No Caulk Needed
- Patented

(Not for use with standing seam roofing.)

Snowguard Powder Coating Color Chart

Ash Gray	Black	Bone White	Bronze	Brown	Burgundy
Charcoal	Clay	Colonial Red	Copper	Crimson Red	Dark Blue
Dark Brown	Dark Red	Fab. Charcoal	Forest Green	Gallery Blue	Galvalume
Green	Hartford Green	Hemlock Green <i>(New Color)</i>	Ivory	Light Gray	Light Stone
Medium Bonze	Musket Gray	Patina Green	Pewter Gray	Red	Sierra Tan
Slate Blue	Slate Gray	Slate	Tan	White	

SIZES FOR STANDARD SOLID WOOD POST

MODEL	DESCRIPTION	DIM "A"	DIM "B"
PC4600	STD 4" X 6" POST	3-5/8"	13"
PC6600	STD 6" X 6" POST	5-5/8"	13"

SIZES FOR NAIL LAMINATED WOOD POST

MODEL	DESCRIPTION	DIM "A"	DIM "B"
PC6300	3 PLY 2"X 6" NAIL LAM	4-5/8"	13"
PC6400	4 PLY 2"X 6" NAIL LAM	6-1/8"	18"
PC8300	3 PLY 2"X 8" NAIL LAM	4-5/8"	18"
PC8400	4 PLY 2"X 8" NAIL LAM	6-1/8"	18"

SIZES FOR GLUE LAMINATED WOOD POST

MODEL	DESCRIPTION	DIM "A"	DIM "B"
PC6300GL	3 PLY X 6" GLUE LAM	4 3/16"	13"
PC6400GL	4 PLY X 6" GLUE LAM	5 9/16"	18"
PC8300GL	3 PLY X 8" GLUE LAM	4 3/16"	18"
PC8400GL	4 PLY X 8" GLUE LAM	5 9/16"	18"

Optional uplift kit available for 6000 series and 8000 series bases.
Shipped with bolt.

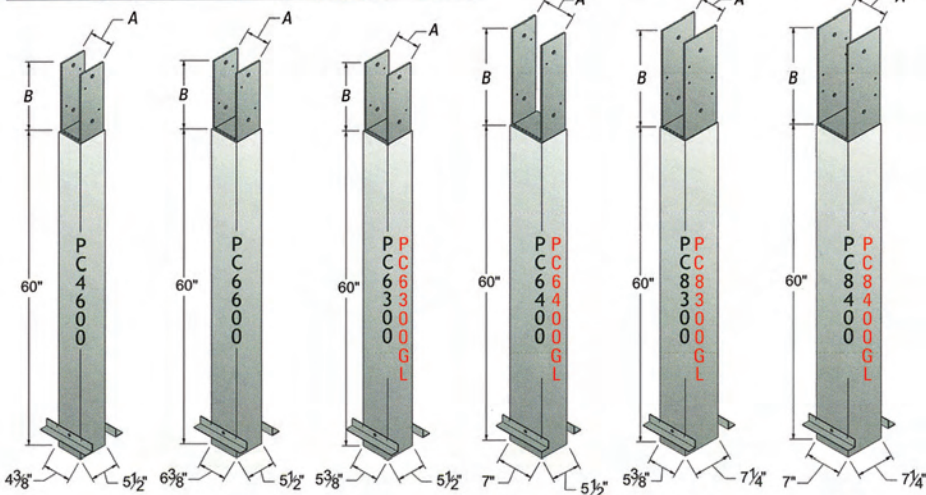

ARE THEY STRONG ENOUGH?

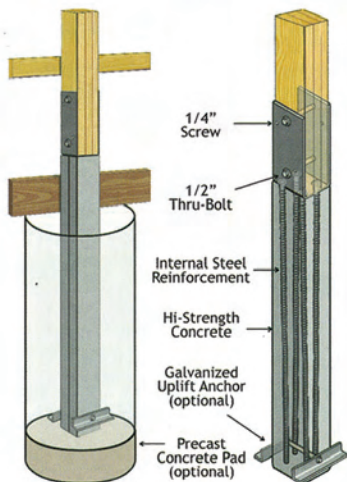

Perma-Columns have been extensively tested by both Wisconsin and Purdue University. In comparative strength tests, Perma Columns have proven to out perform the industry standard for wood columns. Design manuals are available by request.

Or download at www.permacolumneast.com

Heavy Duty Post Frame Anchor Brackets

The Heavy Duty Connection For
Post, Beam, & Column Construction

New Construction
Repair Rotten Posts
Remodel Old Barns
Piers for Decks and Porches

Why Choose Drill Set Installation?

**GLU-LAM POST
AVAILABLE!**

STURDI-WALL



The Sturdi-Wall system allows post frame construction on traditional concrete foundations. Install these engineered anchor brackets with a masonry drill bit and concrete anchors.

PERMA
COLUMN
PERMA COLUMN EAST, LLC
DRILL SET MODELS

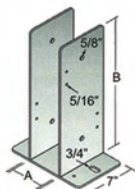

SW 8000 Series

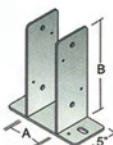

SW 6000 Series

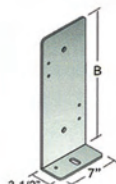

8" Universal

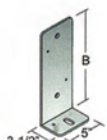

6" Universal

MODELS FOR STANDARD SOLID WOOD POST			
MODEL	DESCRIPTION	DIM "A"	DIM "B"
SW46	STD 4" X 6" POST	3-5/8"	13"
SW66	STD 6" X 6" POST	5-5/8"	13"
MODELS FOR NAIL LAMINATED WOOD POST			
MODEL	DESCRIPTION	DIM "A"	DIM "B"
SW63	3 PLY 2"X 6" NAIL LAM	4-5/8"	13"
SW64	4 PLY 2"X 6" NAIL LAM	6-1/8"	13"
SW83	3 PLY 2"X 8" NAIL LAM	4-5/8"	18"
SW84	4 PLY 2"X 8" NAIL LAM	6-1/8"	18"
SW85	5 PLY 2"X 8" NAIL LAM	7-5/8"	18"

MODELS FOR GLUE LAMINATED WOOD POST			
MODEL	DESCRIPTION	DIM "A"	DIM "B"
SW63GL	3 PLY X 6" GLUE LAM	4 3/16"	13"
SW64GL	4 PLY X 6" GLUE LAM	5 9/16"	13"
SW83GL	3 PLY X 8" GLUE LAM	4 3/16"	18"
SW84GL	4 PLY X 8" GLUE LAM	5 9/16"	18"
MODELS OF UNIVERSAL "L" BRACKETS			
MODEL	DESCRIPTION	DIM "A"	DIM "B"
SW60	6" UNIVERSAL "L"	N/A	13"
SW80	8" UNIVERSAL "L"	N/A	18"

Optional 5/8" x 6" Titan HD Screw
Anchor



Universal brackets can be paired to accommodate custom sized wood posts or utilized at corners.

Stall Doors

Door frames and grille are fully assembled and welded as one piece using 14 ga. steel with a black powder coat gloss finish. Tubular steel pickets are 7/8" OD x 16 ga. and spaced 4" oc. Doors are shown with 2"x6" beveled edge tongue and groove boards, sold separately. Doors 48" w x 88" h.



Standard Door
HD4

Std. Door w/Mesh Insert
HD4, HBM14

Door w/ Swinging Panel
HD4SP

1-800-296-6161

Horse Stall Components

Door Hardware



HTRSET 8' Door Track Kit -Powder Coat Black w/ Mounting Brackets &Trolley Hangers.



HLA -Door Latch

Screws

HSB - Black Screws
(100 pc) #12 x 1 1/4 Pan Hd.

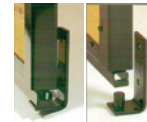

The Door track and Guide Pin keep the bottom of the door aligned when sliding (included with the price of the door). The Pin also serves as a door stop for the door.

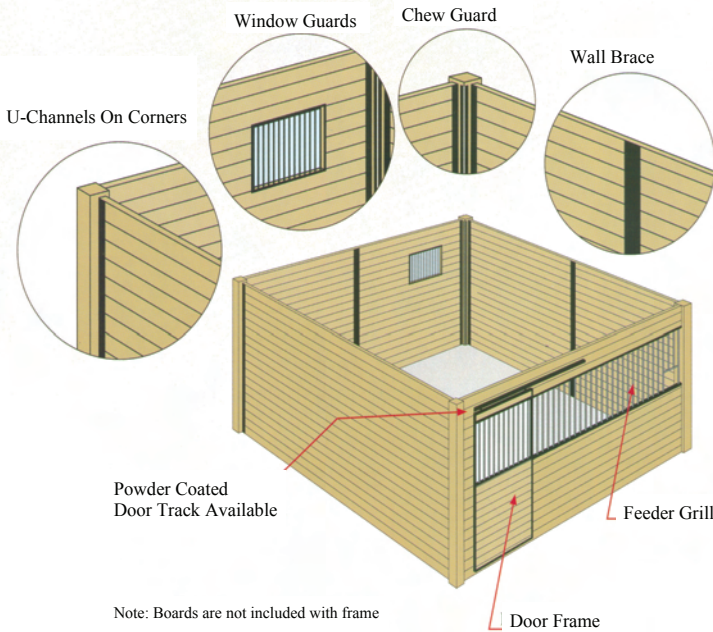

HUCH8 - 8' U Channel Black
HWG3X3 -3'x3' Window Guard Black

HCG8 - 8' Chew Guard Black
HWB8 - 8' Wall Brace Black

Note: Boards are not included with frame

Grill Options

All grills are fully welded as one piece. Tubular steel pickets are 7/8" OD x 16 ga., spaced 4" on center. They are powder coated with a gloss black finish. Grill height is 36"

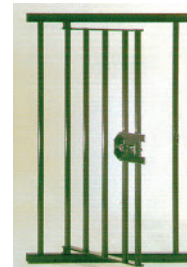

2' Grill w/ Feeder Door
HG2FD



4' Grill w/ (10"x11") feed opening
HG4F011



HG4 - 4' Grill, **HG2** - 2' Grill



3'X3' Window Guard
HWG3X3

#2 Yellow Pine:
2x6 & 2x8
8',10',12',14',16'

Treated:
2x6 & 2x8
8',10',12',14',16'

All lumber is planed on both sides, then the boards are tongue & grooved. Finished boards are V grooved on one side and square edge on the other side

Feeder Options

HHRW- Wall Hay Rack



HCF- Reversible Feeder Door



We Manufacture

Horse Stalls Components			APM Inc. 1-800-296-6161		
Item	Screws Needed	Description	Price	Quantity	Total Screw Count
Doors					
HD4	34	48"w x 88"h Door Frame Black			
HD4SP	34	48"w x 88"h Door Frame with swinging panel Black			
HBM14	34	Door Bottom Mesh Insert Black			
Grills					
HG2	4	2' w x 3' h Grill Black			
HG2FD	4	2' w x 3' h Grill with feeder Door Black			
HG4	8	4' w x 3' h Grill Black			
HG4F011	8	4' w x 3' h Grill with (10"x11") feed opening Black			
HWG3X3	6	36-1/2" x 36-1/2" Window Guard Black			
Hardware					
HSB		Black Screws #12 x 1-1/4" Pan Head - 100 count			
HTRSET		8' Sliding Door Track, w/ bracket & trolley Black			
HLA	10	Horse Stall Door Latch Black			
HCG8	12	8' Chew Guard Black			
HUCH8	11	8' U Channel Black			
HWB8	19	8' Wall Brace Black			
HCF	34	Reversible Feeder Black			
HHRW	5	Wall Hay Rack Black			
Note: Screws are not included with doors, grills, or hardware you must order them separately					
Lumber					
2608TGYP		2X6X8 T&G YELLOW PINE			
2610TGYP		2X6X10 T&G YELLOW PINE			
2612TGYP		2X6X12 T&G YELLOW PINE			
2614TGYP		2X6X14 T&G YELLOW PINE			
2616TGYP		2X6X16 T&G YELLOW PINE			
2808TGYP		2X8X8 T&G YELLOW PINE			
2810TGYP		2X8X10 T&G YELLOW PINE			
2812TGYP		2X8X12 T&G YELLOW PINE			
2814TGYP		2X8X14 T&G YELLOW PINE			
2816TGYP		2X8X16 T&G YELLOW PINE			
Note: We also manufacture treated T&G					
Lumber calculations for Horse Stalls (as illustrated in literature)			Pieces		
		2x6 T&G Boards for Stall Fronts 8' high w/ 3ft Grills *		12 per-front	
		2x6 T&G Boards for Side Walls or Back Walls 8' high		19 per-wall	
		OR			
		2x8 T&G Boards for Stall Fronts 8' high w/ 3ft Grills *		9 per front	
		2x8 T&G Boards for Side Walls or Back Walls 8' high		14 per wall	
* Stall Fronts w/3ft. Grills as illustrated in our literature piece, lumber quantity is for 1 front, which includes the door and front wall portion					
If your stall front is 10' wide, then order 2x6 or 2x8 x 10' long (4' will be for door and 6' will be for wall)					
If your stall front is 12' wide, then order 2x6 or 2x8 x 12' long (4' will be for door and 8' will be for wall)					